

specter

SPECTER SLIM MODULES
SNOOT 2

bold
lighting



SNOOT 2

Our Magnetic track system, SPECTER, is a highly configurable, 2 circuits, 24VDC low voltage track system. Thanks to its magnet mounting technology, the modules are inter-changeable instantaneously. Our track is available in ceiling pendant, surface and recessed mounting for both ceiling and walls. SPECTER track is also available with an optional linear uplight feature. The snoot module complements the SPECTER range with a minimalistic cylinder track-head equipped with a wide range of optics and optical accessories allowing professional scenography lighting.

- Up to 2432lm delivered output
- Various optical accessories available such as beam shaping lenses and Honeycomb louvers
- Beam options, narrow, medium, flood and wide
- Fixtures designed to mount in SPECTER track
- Available in 4 standard finishes: Black, white, silver and bronze

Notes: ¹ Available dimming 0-10V and DALI

Code example: **SPMS-S**28W-W-N827-2

STANDARD FINISHES

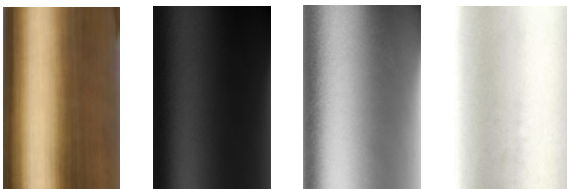

Z

B

S

W

DELIVERED LUMEN OUTPUT

Length	Watts	CRI +80				CRI +90			
		2700K	3000K	3500K	4000K	2700K	3000K	3500K	4000K
2.8"	20W	1809lm	2010lm	2211lm	2432lm	1459lm	1621lm	1783lm	1961lm

Series	Length		Body Finish		Baffle Finish		Beam Angle		CRI		Color Temp		Circuit	
SPMS-S	28	2.8"	W	White	W	White	N	12°	8	+80	27	2700K	1	1-Circuit
			B	Black	B	Black	M	24°			9	+90		
			S	Silver	S	Silver	F	36°			35	3500K		
			Z	Bronze	Z	Bronze	H	50°			40	4000K		
			X	Custom	X	Custom								



Bold Lighting
4710 Ecton Dr., Marietta, GA 30066, USA
info@boldlighting.us www.boldlighting.us
t: +1-678-903-4061

Photometric data:
Type C Polar Curves

12° Beam Angle

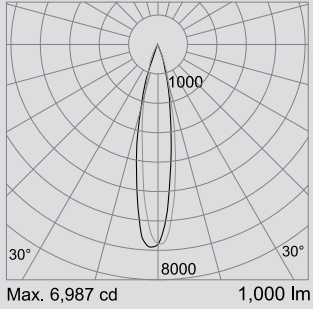

24° Beam Angle

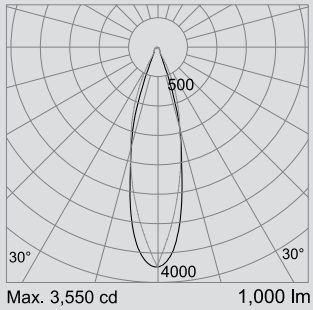

36° Beam Angle

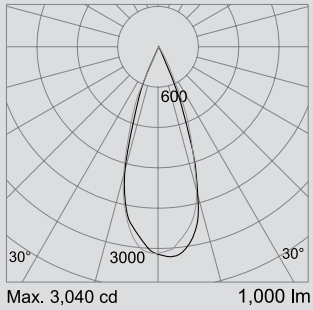

50° Beam Angle

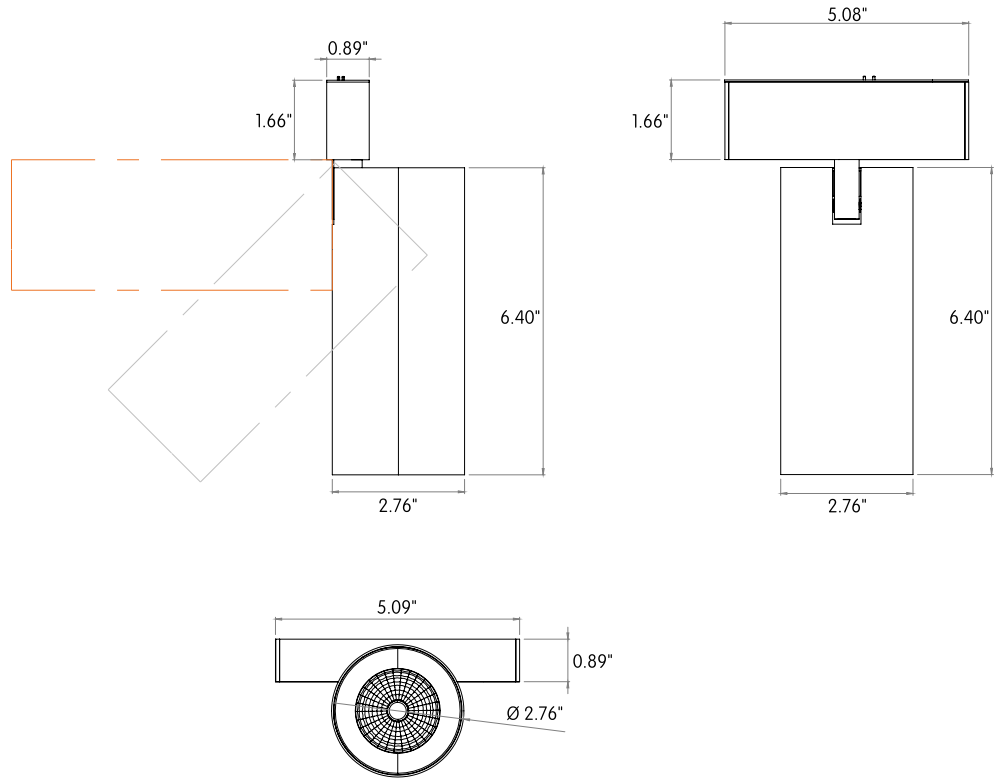
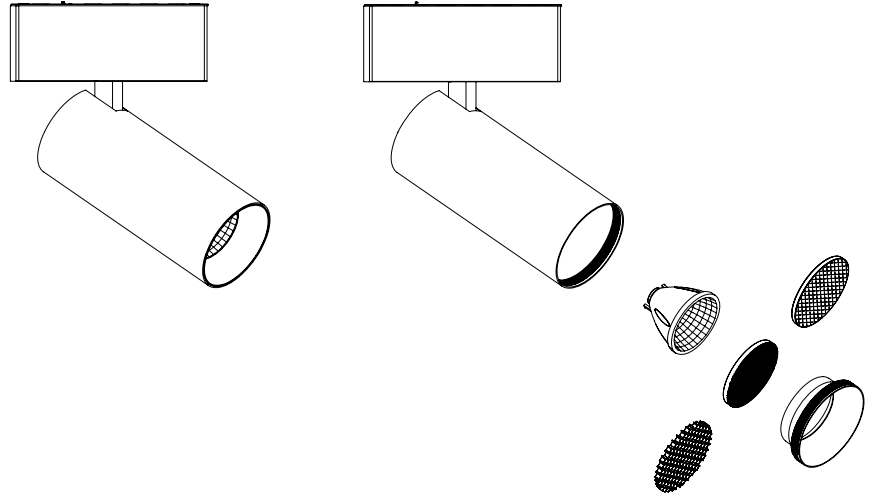
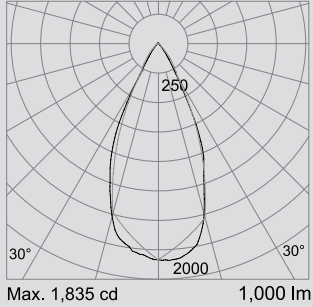

OPTICAL ACCESSORIES

Lenses and anti-glare devices

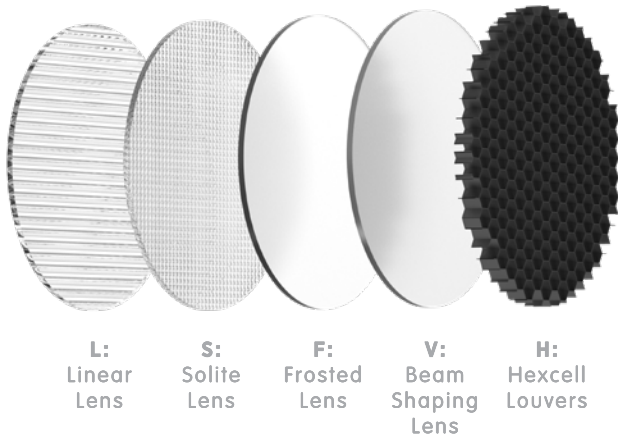

Fits model # / Size		Beam		Finish	
Snoot 2	Diameter 2.8"	S	Solite	—	None
		L	Linear	BL	Flat Black
		F	Frosted	SL	Silver
		V	Beam Shaping	WH	White
		H	Hexcell Louvers		

Beam Shaping lenses Options

	No Filter Beam Shaping Filter	C-HE10	C-HE15	C-HE20	C-HE30	C-HE40	C-HE55	C-HE80
FWHM Beam Angle	15°	18°	21°	25°	35°	46°	65°	80°

Special Beam Shapes	No Filter Beam Shaping Filter	Elliptical 6010	Elliptical 6030	Direction Turning 8°	Direction Turning 20°	C-HE40	C-HE55	C-HE80
FWHM Beam Angle	15°	60° x 10°	60° x 30°	▷ 8°	▷ 20°	46°	65°	80°